

# 820S / 820LC

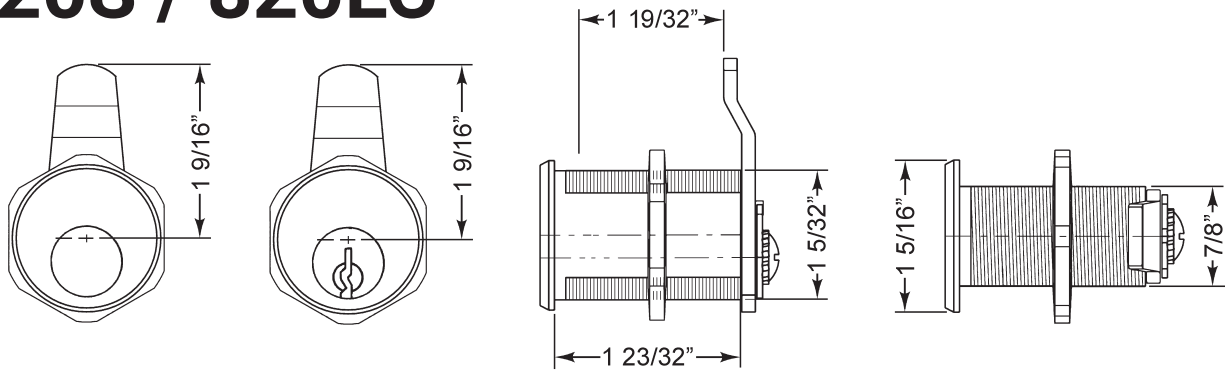

## IMPORTANT:

1. It is highly recommended that you install the **cam/prong driver** and **lock cylinder** into the lock body and cycle to the locked position **before** assembling cam, cam shifter and stop pin onto the back of the lock.
2. For lock to function correctly, you must install the universal driver into back of cylinder according to the directions below.

<p><b>Correct installation (either position below will work)</b></p> <div style="display: flex; justify-content: space-around;"> <div style="text-align: center;"> <p>Position 1</p> <p>Universal Driver</p> </div> <div style="text-align: center;"> <p>Position 2</p> <p>Universal Driver</p> </div> </div>	<p><b>Incorrect Installation</b></p> <p>For proper cam assembly <b>DO NOT</b> install universal driver in position below.</p> <div style="text-align: center;"> <p>Universal Driver</p> </div>
---	--

## Typical Installation

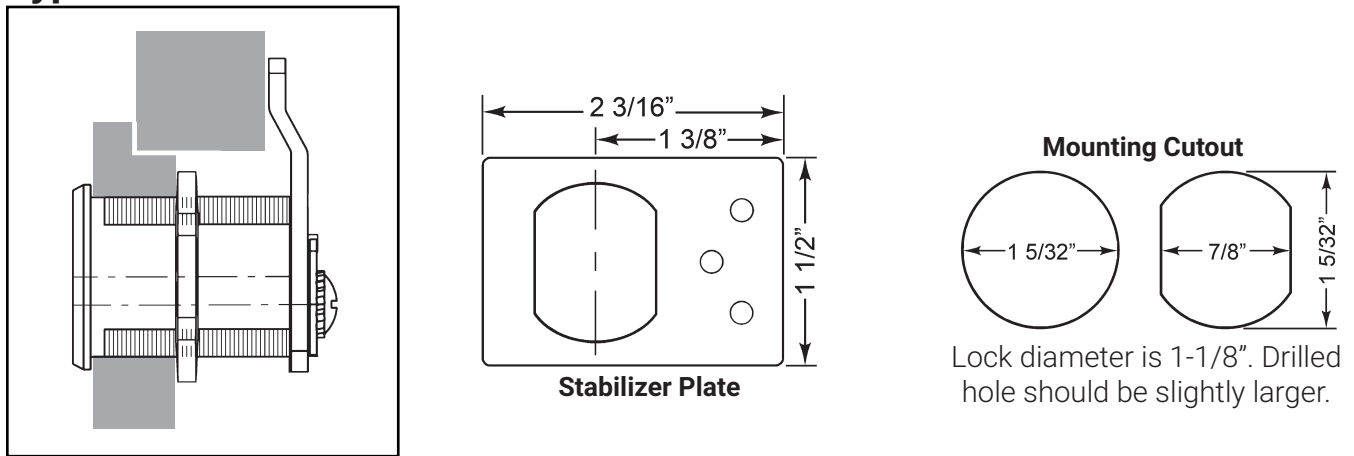

## 820S / 820LC

Assembled with vertical long cam 720-3-2 or  
extra long 3" cam 720-3-4



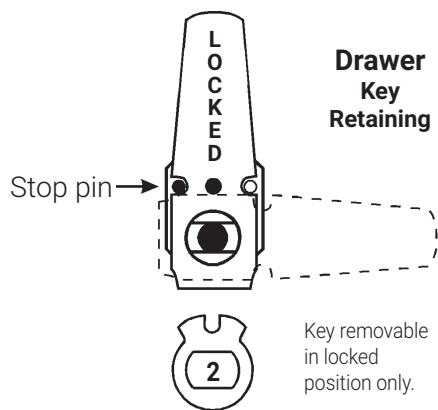
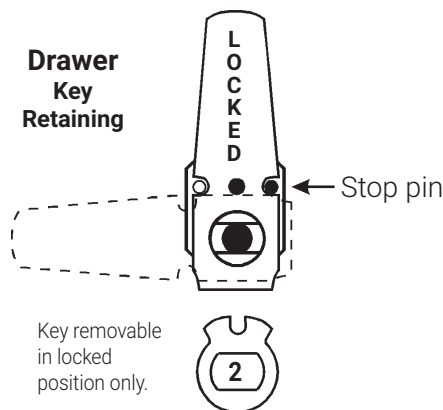
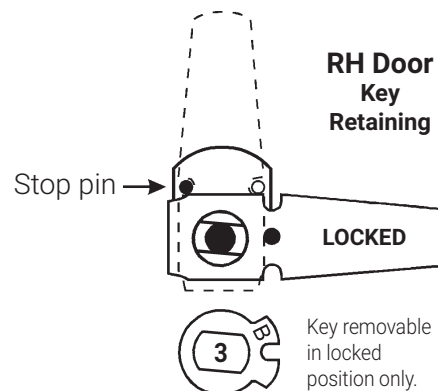
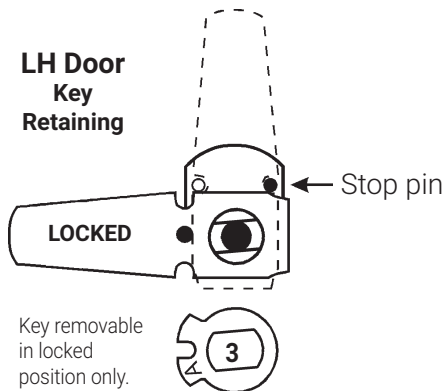
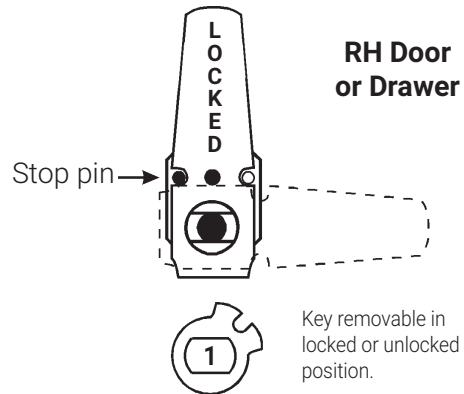
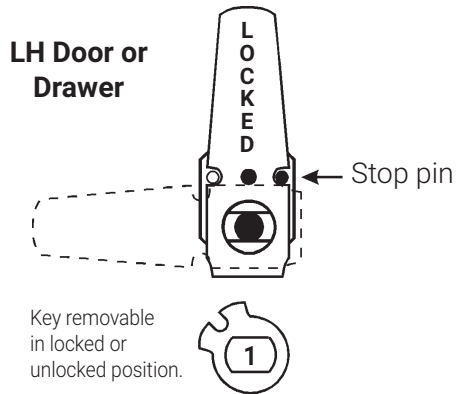

<p><b>720-CDLM</b> lost motion cam shifter (non-key-retaining)</p>	<p><b>720-KR</b> key retaining drawer cam shifter</p>	<p><b>720-CDDM (A Side)</b> key retaining door cam shifter</p>	<p><b>720-CDDM (B Side)</b> key retaining door cam shifter</p>

**IMPORTANT!** If your cam has a brass pin between the two notched cut outs use these instructions, otherwise see page 3.



## 820S / 820LC

Assembled with vertical long cam 720-3-2 or extra long 3" cam 720-3-4

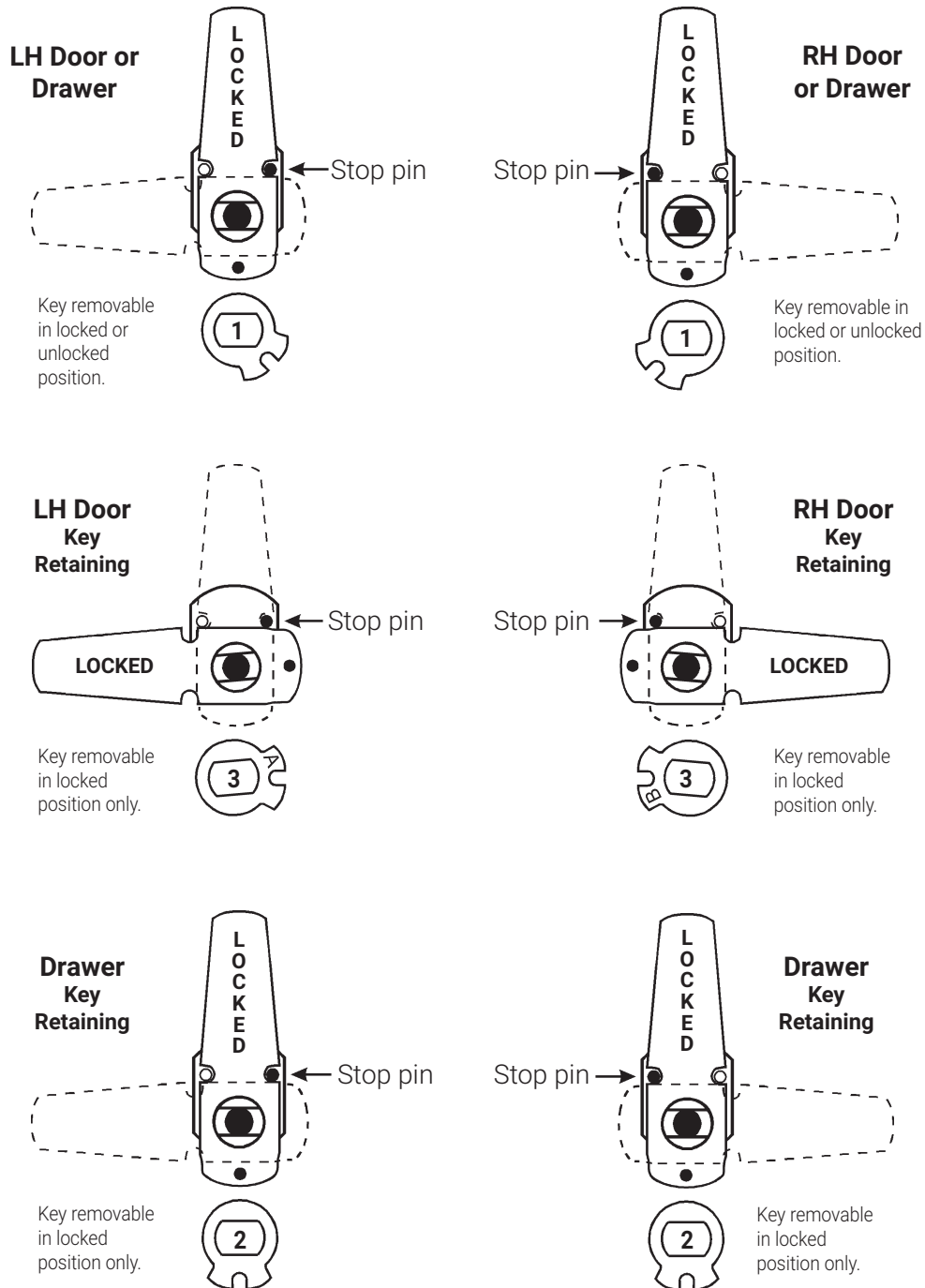

 <p><b>1</b> 720-CDLM lost motion cam shifter (non-key-retaining)</p>	 <p><b>2</b> 720-KR key retaining drawer cam shifter</p>	 <p><b>3</b> 720-CDDM (A Side) key retaining door cam shifter</p>	 <p><b>3</b> 720-CDDM (B Side) key retaining door cam shifter</p>
--	---	--	--

**IMPORTANT!** If your cam has a brass pin on the bottom of the cam use these instructions, otherwise see page 2.





# 820S / 820LC

Assembled with short cam 720-3-1

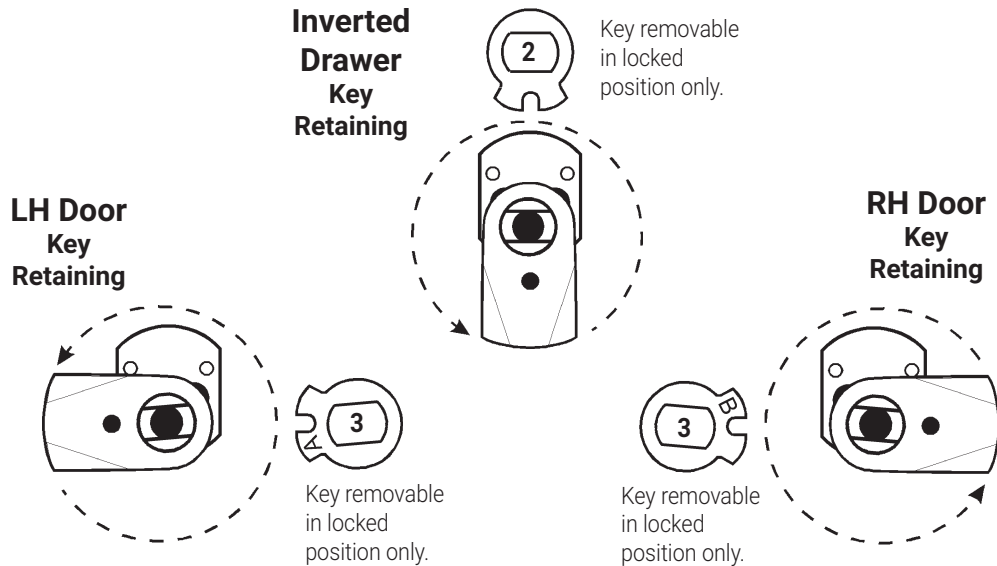
 <p><b>2</b> 720-KR key retaining drawer cam shifter</p>
 <p><b>3</b> 720-CDDM (A Side) key retaining door cam shifter</p>
 <p><b>3</b> 720-CDDM (B Side) key retaining door cam shifter</p>



**Assembled with inverted long cam 720-3-3 or 720-3-5**

 <p><b>1</b> 720-CDLM lost motion cam shifter (non-key-retaining)</p>
 <p><b>2</b> 720-KR key retaining drawer cam shifter</p>

